

INSTRUCTION MANUAL

# Rotary Hammer

HR4002

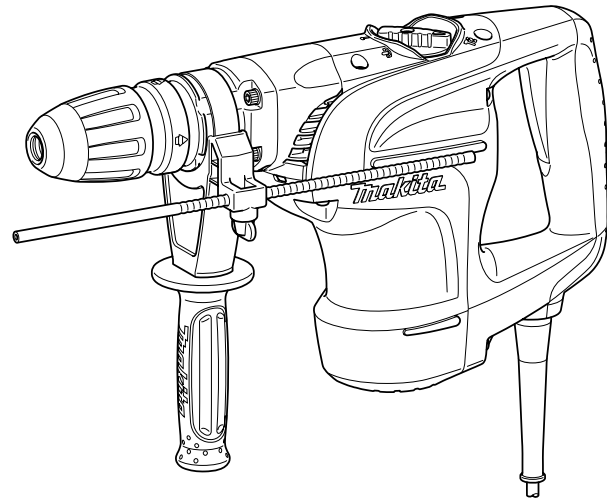

008056

 DOUBLE INSULATION

**⚠ WARNING:**

For your personal safety, READ and UNDERSTAND before using.  
SAVE THESE INSTRUCTIONS FOR FUTURE REFERENCE.

ENGLISH (Original instructions)

# SPECIFICATIONS

Model		HR4002
Capacities	Carbide-tipped bit	40 mm
	Core bit	105 mm
No load speed (min <sup>-1</sup> )		680
Blows per minute		2,500
Overall length		458 mm
Net weight		6.6 kg
Safety class		II

- Due to our continuing programme of research and development, the specifications herein are subject to change without notice.
- Specifications may differ from country to country.
- Weight according to EPTA-Procedure 01/2003

END201-5

ENG215-2

## Symbols

The following show the symbols used for the equipment. Be sure that you understand their meaning before use.



- Read instruction manual.



- DOUBLE INSULATION



- Only for EU countries  
Do not dispose of electric equipment together with household waste material! In observance of European Directive 2002/96/EC on waste electric and electronic equipment and its implementation in accordance with national law, electric equipment that have reached the end of their life must be collected separately and returned to an environmentally compatible recycling facility.

ENE044-1

## Intended use

The tool is intended for hammer drilling in brick, concrete and stone as well as for chiselling work.

ENF002-1

## Power supply

The tool should be connected only to a power supply of the same voltage as indicated on the nameplate, and can only be operated on single-phase AC supply. They are double-insulated in accordance with European Standard and can, therefore, also be used from sockets without earth wire.

ENG102-3

## Noise

The typical A-weighted noise level determined according to EN60745:

- Sound pressure level (L<sub>pA</sub>) : 92 dB(A)
- Sound power level (L<sub>WA</sub>) : 103 dB(A)
- Uncertainty (K) : 3 dB(A)

### Wear ear protection

## Vibration

The vibration total value (tri-axial vector sum) determined according to EN60745:

- Work mode : chiseling function
- Vibration emission (a<sub>n,CHeq</sub>) : 10.5 m/s<sup>2</sup>
- Uncertainty (K) : 1.5 m/s<sup>2</sup>

ENG303-2

- Work mode : hammer drilling into concrete
- Vibration emission (a<sub>n,HD</sub>) : 17.5 m/s<sup>2</sup>
- Uncertainty (K) : 1.5 m/s<sup>2</sup>

ENG901-1

- The declared vibration emission value has been measured in accordance with the standard test method and may be used for comparing one tool with another.
- The declared vibration emission value may also be used in a preliminary assessment of exposure.

## ⚠WARNING:

- The vibration emission during actual use of the power tool can differ from the declared emission value depending on the ways in which the tool is used.
- Be sure to identify safety measures to protect the operator that are based on an estimation of exposure in the actual conditions of use (taking account of all parts of the operating cycle such as the times when the tool is switched off and when it is running idle in addition to the trigger time).

ENH101-13

## For European countries only

### EC Declaration of Conformity

We Makita Corporation as the responsible manufacturer declare that the following Makita machine(s):

Designation of Machine:  
Rotary Hammer

Model No./ Type: HR4002

are of series production and

**Conforms to the following European Directives:**

98/37/EC until 28th December 2009 and then with  
2006/42/EC from 29th December 2009

And are manufactured in accordance with the following  
standards or standardised documents:

EN60745

The technical documentation is kept by our authorised  
representative in Europe who is:

Makita International Europe Ltd,  
Michigan, Drive, Tongwell,  
Milton Keynes, MK15 8JD, England

30th January 2009



000230

Tomoyasu Kato  
Director  
Makita Corporation  
3-11-8, Sumiyoshi-cho,  
Anjo, Aichi, JAPAN

GEA005-3

## General Power Tool Safety Warnings

**⚠ WARNING** Read all safety warnings and all  
instructions. Failure to follow the warnings and  
instructions may result in electric shock, fire and/or  
serious injury.

### Save all warnings and instructions for future reference.

The term "power tool" in the warnings refers to your  
mains-operated (corded) power tool or battery-operated  
(cordless) power tool.

#### Work area safety

1. **Keep work area clean and well lit.** Cluttered or  
dark areas invite accidents.
2. **Do not operate power tools in explosive  
atmospheres, such as in the presence of  
flammable liquids, gases or dust.** Power tools  
create sparks which may ignite the dust or fumes.
3. **Keep children and bystanders away while  
operating a power tool.** Distractions can cause  
you to lose control.

#### Electrical safety

4. **Power tool plugs must match the outlet. Never  
modify the plug in any way. Do not use any  
adapter plugs with earthed (grounded) power  
tools.** Unmodified plugs and matching outlets will  
reduce risk of electric shock.

5. **Avoid body contact with earthed or grounded  
surfaces such as pipes, radiators, ranges and  
refrigerators.** There is an increased risk of  
electric shock if your body is earthed or grounded.
6. **Do not expose power tools to rain or wet  
conditions.** Water entering a power tool will  
increase the risk of electric shock.
7. **Do not abuse the cord. Never use the cord for  
carrying, pulling or unplugging the power tool.  
Keep cord away from heat, oil, sharp edges or  
moving parts.** Damaged or entangled cords  
increase the risk of electric shock.
8. **When operating a power tool outdoors, use an  
extension cord suitable for outdoor use.** Use of  
a cord suitable for outdoor use reduces the risk of  
electric shock.
9. **If operating a power tool in a damp location is  
unavoidable, use a residual current device  
(RCD) protected supply.** Use of an RCD reduces  
the risk of electric shock.
10. **Use of power supply via a RCD with a rated  
residual current of 30mA or less is always  
recommended.**

#### Personal safety

11. **Stay alert, watch what you are doing and use  
common sense when operating a power tool.  
Do not use a power tool while you are tired or  
under the influence of drugs, alcohol or  
medication.** A moment of inattention while  
operating power tools may result in serious  
personal injury.
12. **Use personal protective equipment. Always  
wear eye protection.** Protective equipment such  
as dust mask, non-skid safety shoes, hard hat, or  
hearing protection used for appropriate conditions  
will reduce personal injuries.
13. **Prevent unintentional starting. Ensure the  
switch is in the off-position before connecting  
to power source and/or battery pack, picking  
up or carrying the tool.** Carrying power tools  
with your finger on the switch or energising power  
tools that have the switch on invites accidents.
14. **Remove any adjusting key or wrench before  
turning the power tool on.** A wrench or a key left  
attached to a rotating part of the power tool may  
result in personal injury.
15. **Do not overreach. Keep proper footing and  
balance at all times.** This enables better control  
of the power tool in unexpected situations.
16. **Dress properly. Do not wear loose clothing or  
jewellery. Keep your hair, clothing, and gloves  
away from moving parts.** Loose clothes,  
jewellery or long hair can be caught in moving  
parts.

17. **If devices are provided for the connection of dust extraction and collection facilities, ensure these are connected and properly used.** Use of dust collection can reduce dust-related hazards.

#### **Power tool use and care**

18. **Do not force the power tool. Use the correct power tool for your application.** The correct power tool will do the job better and safer at the rate for which it was designed.
19. **Do not use the power tool if the switch does not turn it on and off.** Any power tool that cannot be controlled with the switch is dangerous and must be repaired.
20. **Disconnect the plug from the power source and/or the battery pack from the power tool before making any adjustments, changing accessories, or storing power tools.** Such preventive safety measures reduce the risk of starting the power tool accidentally.
21. **Store idle power tools out of the reach of children and do not allow persons unfamiliar with the power tool or these instructions to operate the power tool.** Power tools are dangerous in the hands of untrained users.
22. **Maintain power tools. Check for misalignment or binding of moving parts, breakage of parts and any other condition that may affect the power tool's operation. If damaged, have the power tool repaired before use.** Many accidents are caused by poorly maintained power tools.
23. **Keep cutting tools sharp and clean.** Properly maintained cutting tools with sharp cutting edges are less likely to bind and are easier to control.
24. **Use the power tool, accessories and tool bits etc. in accordance with these instructions, taking into account the working conditions and the work to be performed.** Use of the power tool for operations different from those intended could result in a hazardous situation.

#### **Service**

25. **Have your power tool serviced by a qualified repair person using only identical replacement parts.** This will ensure that the safety of the power tool is maintained.
26. **Follow instruction for lubricating and changing accessories.**
27. **Keep handles dry, clean and free from oil and grease.**

## **ROTARY HAMMER SAFETY WARNINGS**

1. **Wear ear protectors.** Exposure to noise can cause hearing loss.
2. **Use auxiliary handle(s), if supplied with the tool.** Loss of control can cause personal injury.
3. **Hold power tool by insulated gripping surfaces, when performing an operation where the cutting accessory may contact hidden wiring or its own cord.** Cutting accessory contacting a "live" wire may make exposed metal parts of the power tool "live" and could give the operator an electric shock.
4. **Wear a hard hat (safety helmet), safety glasses and/or face shield. Ordinary eye or sun glasses are NOT safety glasses. It is also highly recommended that you wear a dust mask and thickly padded gloves.**
5. **Be sure the bit is secured in place before operation.**
6. **Under normal operation, the tool is designed to produce vibration. The screws can come loose easily, causing a breakdown or accident. Check tightness of screws carefully before operation.**
7. **In cold weather or when the tool has not been used for a long time, let the tool warm up for a while by operating it under no load. This will loosen up the lubrication. Without proper warm-up, hammering operation is difficult.**
8. **Always be sure you have a firm footing. Be sure no one is below when using the tool in high locations.**
9. **Hold the tool firmly with both hands.**
10. **Keep hands away from moving parts.**
11. **Do not leave the tool running. Operate the tool only when hand-held.**
12. **Do not point the tool at any one in the area when operating. The bit could fly out and injure someone seriously.**
13. **Do not touch the bit or parts close to the bit immediately after operation; they may be extremely hot and could burn your skin.**
14. **Some material contains chemicals which may be toxic. Take caution to prevent dust inhalation and skin contact. Follow material supplier safety data.**

**SAVE THESE INSTRUCTIONS.**

**⚠WARNING:**

**DO NOT** let comfort or familiarity with product (gained from repeated use) replace strict adherence to safety rules for the subject product. **MISUSE** or failure to follow the safety rules stated in this instruction manual may cause serious personal injury.

## FUNCTIONAL DESCRIPTION

**⚠CAUTION:**

- Always be sure that the tool is switched off and unplugged before adjusting or checking function on the tool.

### Switch action

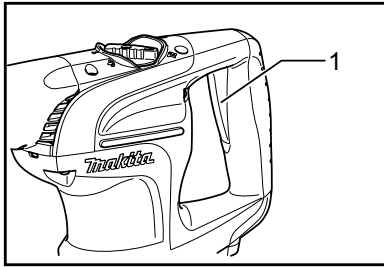

008075

1. Switch trigger

**⚠CAUTION:**

- Before plugging in the tool, always check to see that the switch trigger actuates properly and returns to the "OFF" position when released.

To start the tool, simply pull the switch trigger. Release the switch trigger to stop.

### Selecting the action mode

#### Rotation with hammering

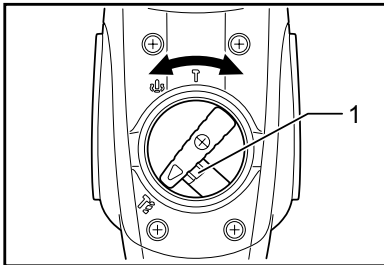

008060

1. Lock button

For drilling in concrete, masonry, etc., depress the lock button and rotate the change lever so that the pointer points to the  symbol. Use a tungsten-carbide tipped bit.

### Hammering only

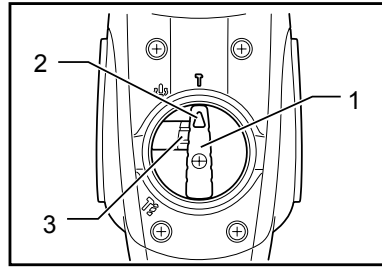

008062

1. Change lever
2. Pointer
3. Lock button

For chipping, scaling or demolition operations, depress the lock button and rotate the change lever so that the pointer points to the  symbol. Use a bull point, cold chisel, scaling chisel, etc.

**⚠CAUTION:**

- Do not rotate the change lever when the tool is running under load. The tool will be damaged.
- To avoid rapid wear on the mode change mechanism, be sure that the change lever is always positively located in one of the two or three action mode positions.

### Torque limiter

The torque limiter will actuate when a certain torque level is reached. The motor will disengage from the output shaft. When this happens, the bit will stop turning.

**⚠CAUTION:**

- As soon as the torque limiter actuates, switch off the tool immediately. This will help prevent premature wear of the tool.

## ASSEMBLY

**⚠CAUTION:**

- Always be sure that the tool is switched off and unplugged before carrying out any work on the tool.

### Side handle (accessory)

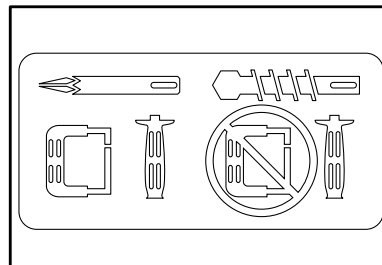

003139

**⚠ CAUTION:**

- Use the side handle only when chipping, scaling or demolishing. Do not use it when drilling in concrete, masonry, etc. The tool cannot be held properly with this side handle when drilling.

The side handle can be swung 360° on the vertical and secured at any desired position. It also secures at eight different positions back and forth on the horizontal. Just loosen the clamp nut to swing the side handle to a desired position. Then tighten the clamp nut securely.

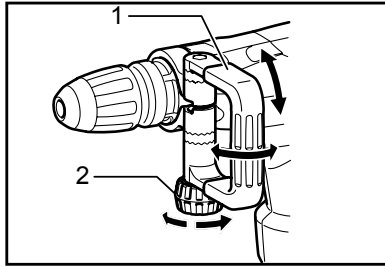

1. Side handle
2. Clamp nut

006315

**Side grip**

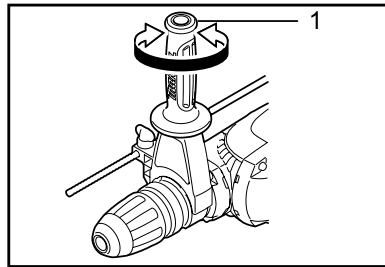

1. Side grip

008065

**⚠ CAUTION:**

- Always use the side grip to ensure operating safety when drilling in concrete, masonry, etc.

The side grip swings around to either side, allowing easy handling of the tool in any position. Loosen the side grip by turning it counterclockwise, swing it to the desired position and then tighten it by turning clockwise.

**Bit grease (optional accessory)**

Coat the bit shank head beforehand with a small amount of bit grease (about 0.5 - 1 g; 0.02 - 0.04 oz.). This chuck lubrication assures smooth action and longer service life.

**Installing or removing the bit**

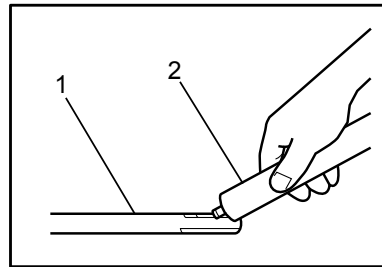

1. Bit shank
2. Bit grease

003150

Clean the bit shank and apply bit grease before installing the bit.

Insert the bit into the tool. Turn the bit and push it in until it engages.

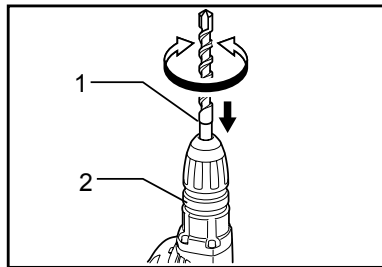

1. Bit
2. Chuck cover

008057

If the bit cannot be pushed in, remove the bit. Pull the chuck cover down a couple of times. Then insert the bit again. Turn the bit and push it in until it engages.

After installing, always make sure that the bit is securely held in place by trying to pull it out.

To remove the bit, pull the chuck cover down all the way and pull the bit out.

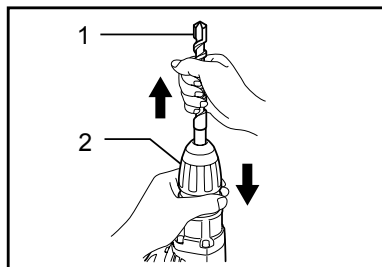

1. Bit
2. Chuck cover

008059

## Bit angle (when chipping, scaling or demolishing)

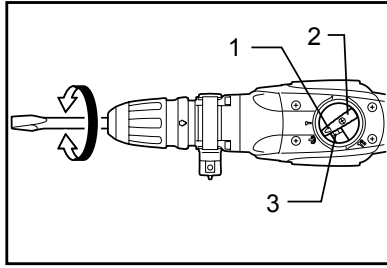

008063

1. Pointer
2. Change lever
3. Lock button

The bit can be secured at 12 different angles. To change the bit angle, depress the lock button and rotate the change lever so that the pointer points to the  symbol. Turn the bit to the desired angle.

Depress the lock button and rotate the change lever so that the pointer points to the  symbol. Then make sure that the bit is securely held in place by turning it slightly.

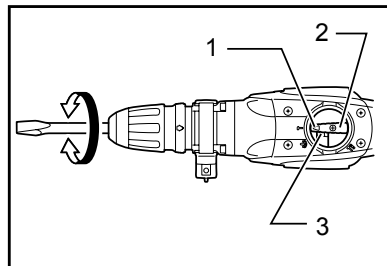

008064

1. Pointer
2. Change lever
3. Lock button

## Depth gauge

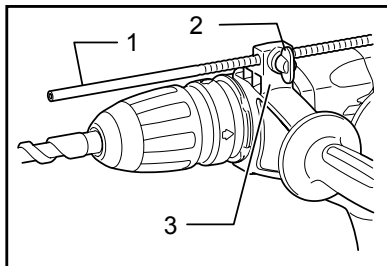

008067

1. Depth gauge
2. Clamp screw
3. Grip base

The depth gauge is convenient for drilling holes of uniform depth. Insert the depth gauge into the hole in the grip base. Adjust the depth gauge to the desired depth and then tighten the clamp screw to secure the depth gauge.

The depth gauge is convenient for drilling holes of uniform depth. Loosen the clamp screw and adjust the depth gauge to the desired depth. After adjusting, tighten the clamp screw firmly.

### NOTE:

- The depth gauge cannot be used at the position where the depth gauge strikes against the tool

body.

- The depth gauge cannot be used at the position where the depth gauge strikes against the gear housing/motor housing.

## OPERATION

### Hammer drilling operation

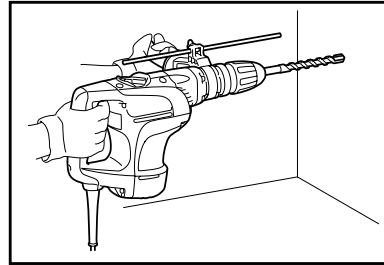

008066

Set the change lever to the  symbol.

Position the bit at the desired location for the hole, then pull the switch trigger. Do not force the tool. Light pressure gives best results. Keep the tool in position and prevent it from slipping away from the hole.

Do not apply more pressure when the hole becomes clogged with chips or particles. Instead, run the tool at an idle, then remove the bit partially from the hole. By repeating this several times, the hole will be cleaned out and normal drilling may be resumed.

### ⚠ CAUTION:

- When the bit begins to break through concrete or if the bit strikes reinforcing rods embedded in concrete, the tool may react dangerously. Maintain good balance and safe footing while holding the tool firmly with both hands to prevent dangerous reaction.

### Blow-out bulb (optional accessory)

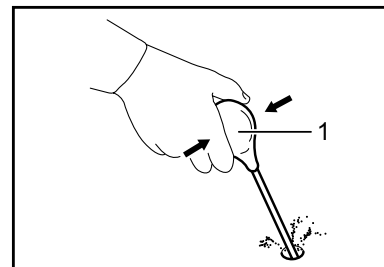

002449

1. Blow-out bulb

After drilling the hole, use the blow-out bulb to clean the dust out of the hole.



## Chipping/Scaling/Demolition

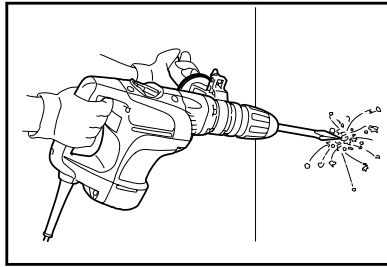

008068

- SDS-MAX tile chisel
- SDS-MAX clay spade
- Hammer grease
- Bit grease
- Side handle
- Side grip
- Depth gauge
- Blow-out bulb
- Safety goggles
- Carrying case

Set the change lever to the  $\uparrow$  symbol.

Hold the tool firmly with both hands. Turn the tool on and apply slight pressure on the tool so that the tool will not bounce around, uncontrolled. Pressing very hard on the tool will not increase the efficiency.

## MAINTENANCE

### **⚠CAUTION:**

- Always be sure that the tool is switched off and unplugged before attempting to perform inspection or maintenance.

### Lubrication

### **⚠CAUTION:**

- This servicing should be performed by Makita Authorized Service Centers only.

This tool requires no hourly or daily lubrication because it has a grease-packed lubrication system. It should be relubricated regularly. Send the complete tool to Makita Authorized or Factory Service Center for this lubrication service.

To maintain product SAFETY and RELIABILITY, repairs, any other maintenance or adjustment should be performed by Makita Authorized Service Centers, always using Makita replacement parts.

## ACCESSORIES

### **⚠CAUTION:**

- These accessories or attachments are recommended for use with your Makita tool specified in this manual. The use of any other accessories or attachments might present a risk of injury to persons. Only use accessory or attachment for its stated purpose.

If you need any assistance for more details regarding these accessories, ask your local Makita Service Center.

- SDS-Max Carbide-tipped bits
- SDS-Max bull point
- SDS-MAX cold chisel
- SDS-MAX scaling chisel









Makita Corporation Anjo, Aichi, Japan

884714A223